



贝特卫士®
www.betterfuse.com

更好的电路安全卫士! ⚡

You build electronics , We safeguard them !

2018/2019

Product Portfolio

You build electronics ,
We safeguard them !

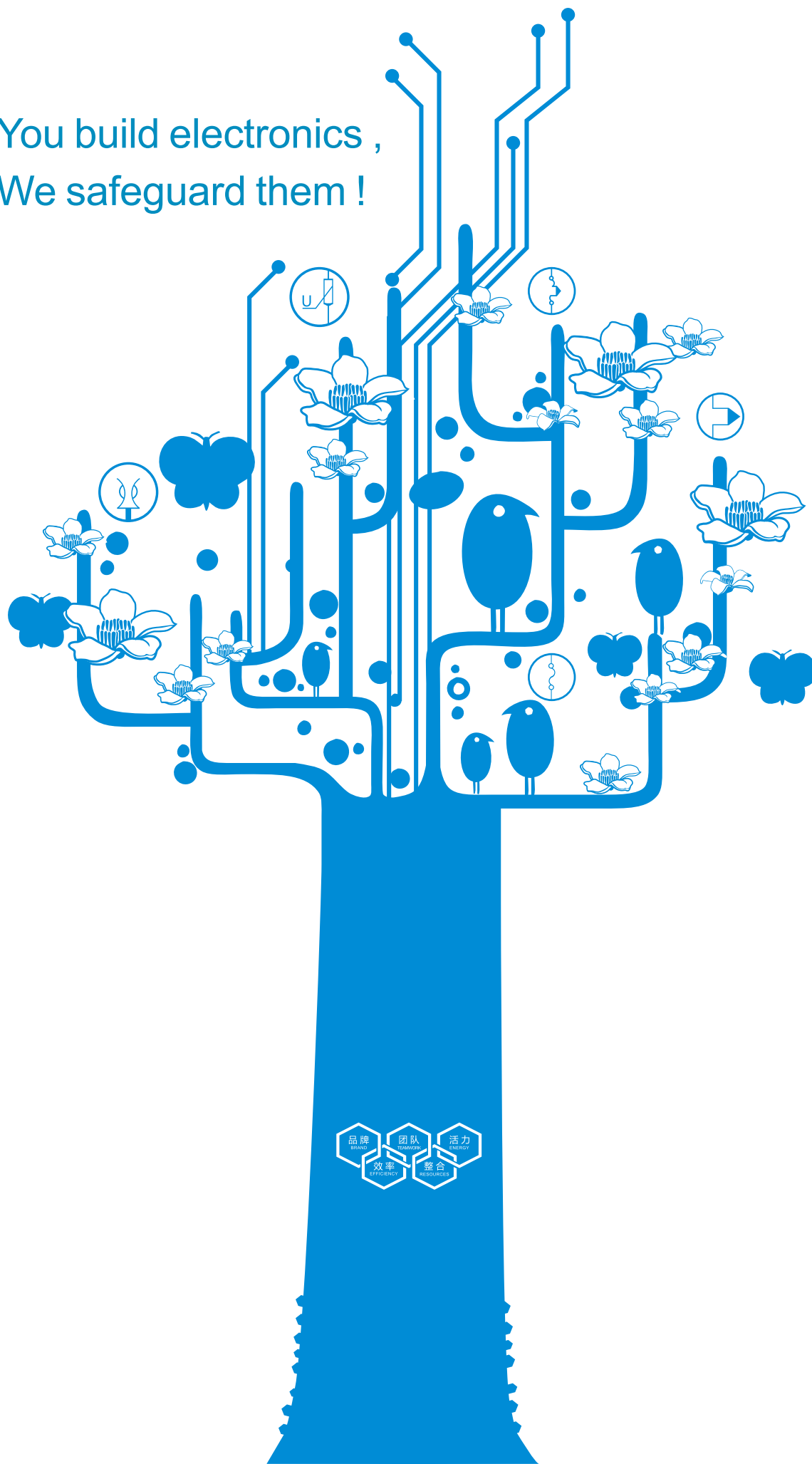

Contents



CEO Address	04
Company History	05
Company Profile	06



OC (Over-Current) Protection 07-18

SMD Fuse 0402 Size Series
SMD Fuse 0603 Size Series
SMD Fuse 1206 Size Series
SMD Fuse 2410 Size Series
SMD Fuse 1140 Size Series
Cartridge Fuse 2x7mm Series
Cartridge Fuse 3x10mm Series
Cartridge Fuse 4x13mm Series
Cartridge Fuse 5x20mm Series
Cartridge Fuse 6x25mm Series
Cartridge Fuse 6x30mm Series
Cartridge Fuse 6x40mm Series
Car Fuse Series
Through Hole TE5 Series
Through Hole TK5 Series
SMD PPTC Series
Through Hole PPTC Series



OT(Over-Temperature) Thermal Protection 19-20

Thermal Fuses Series
Thermal Switches Series



OV (Over-Voltage) Protection 21

ESD Suppressors



Multiple Protection 22

BTU Series



Accessories Terminal 23-27

Fuse Holders
Fuse Clips
Terminals

CEO Address

The year of 2017 already belongs to the past. Here in Europe the new summer has already started. At Betterfuse, we are releasing a new annual catalogue again. It appears that this is a good time for reflection and to summarize. What kind of year is 2018 and will it not be as smooth as before? No matter what, Betterfuse can only move forward!

- Break through 200 million revenue
- More than 10 million taxes.
- Turnover grew by 25.22%.
- Achieved C turn's PE
- Successful completion of the first year of the three-year doubling plan

All above achievements look quite promising, but we had to weather quite some storms from our external business environment, because our customers are not doing as well as we would like, and we do feel the pressure. How can we still ensure business growth?

- Upgrade ERP Group Management System
- Introduced MES intelligent manufacturing system
- Further expand OT over temperature products
- Further expand the globalization of marketing and cooperation
- Not taking net profit as the primary goal

Our business environment is changing, and the global economy also is getting more complicated, in these times innovation and keeping up with the developments are the only way to move forward, only in this way can we create real and quantifiable value for our customers, and consolidate BETTERFUSE as a truly global brand.

In the absence dodging responsibility, the year 2018 is already half over. We have no choice but to continue our journey. Howling at the past and hesitation is not our style. Only drawing out the sword and pointing it towards our adversaries show the true and heroic spirit of this enterprise. Only moving forward and taking on new ventures will find our way out!

On a final note, you shall always keep to your original aspirations, which lead you to success. Betterfuse has marched through 15 hard years, and surely we should not fear what the next 15 years hold in store for us? As long as we keep our entrepreneurial spirit, we can ensure that our road will lead us to further heights, together with our customers, our suppliers, and our community!

Enjoy your work and accomplishments,
Yours truly,



David Han
CEO of Betterfuse
In HOLYDAY INN HOTEL, Munich, Germany
June 19, 2018

2017轻轻迈过，欧洲的夏天又在眼前，我们新的目录又在启动，好像又到了我们该总结的时间了；承前启后，2018年是一个什么样的年，还会如之前那么顺不，无论如何，贝特卫士们只能向前！

- 突破2亿的营收
- 税收千万以上。
- 营收成长25.22%。
- 完成C轮融资的引入
- 三年倍增计划的首年任务顺利完成

以上的成绩看起来不错，但外部的环境看起来则是特别有压力，因为我们的客户很不好过，我们也感受到了压力，我们要如何确保成长？

- 升级ERP集团管理系统
- 引入MES智能制造系统
- 进一步扩大OT过温产品
- 进一步扩大全球化的营销和合作
- 不以净利润为首要目标

外部环境在变化，全球的经济也变得扑朔迷离，我们只有不断创新和与时俱进，才有出路，才能在这个经济的低谷期给客户创造价值，打造一个不一样的品牌----贝特卫士，全球的BETTERFUSE。

2018在没有任何推脱之际已过了一半，我们没有更多的选择，只能选择继续上路，惆怅，犹豫，不是我们的风格，唯有亮剑才能展示我们的木棉花的英雄风采，只有进攻和进取才能找到唯一的出路！

最后，不忘初心，方得始终。贝特卫士筚路蓝缕迈过艰辛的十五年，再来一次十五年的长征又会如何？只要保有创业的梦想和一直在路上的精神，我们就能确保一直在路上，与我们的客户，与我们的供应商，与我们的环境！

德国 慕尼黑市 HOLYDAY INN HOTEL
2018年6月19日 夜





Company History

more...

- 2018** In round C financing, Shenzhen Dachen Chuangye Investment, Shenzhen co-win venture capital investment limited, China Venture Capital Inc. and other investment companies invest 30,000,000RMB. Obtain IATF 16949 system certification, Taiwan office was formally established
C轮融资达晨、同创伟业、中国风险等投资资金3000万，取得IATF 16949体系认证，台湾办事处正式成立
- 2017** In round B financing, Shenzhen hi-tech investment co., ltd and other three investment company invest 31,000,000RMB. Joint venture - ADLER china factory was established (Xi'An ADLER electric appliance), Pilot enterprise of "Income Doubling Program" in Dongguan, Establish CPC Better Guardian party branch
B轮融资深圳高新投等四家风投3100万，合资成立ADLER中国制造工厂(西安艾德乐电器)，东莞市“倍增计划”试点企业、中共贝特卫士党支部成立
- 2016** Successfully landed the Chinese OTC Market and acquired the qualification of the intellectual property management system certification, obtained "chip fuse"and "miniature fuse" two high-tech products certifications
贝特卫士成功登陆新三板，获得“知识产权管理体系认证”资质，获得“片式保险丝”和“小型保险丝”两项高新技术产品证书
- 2015** Obtained the certification of "Engineering Research Center of Circuit Protection Components in Guangdong Province"
取得“广东省电路保护元件工程技术研究中心”资格认定
- 2014** Accessed to the certification of ISO 14001 and QC 080000 quality management system and successfully registered "Betterfuse" brand trademark as "贝特卫士", which pronounced similar to "Betterfuse"
通过"ISO 14001"和"QC 080000"质量管理体系认证，成功注册“贝特卫士”品牌商标
- 2012** Completion of the stock reform, obtain angel investment foudation 10 million
股改完，引入天使投资汇通盈富1000万
- 2011** Accessed to the qualification of "high-tech enterprise"
获得“高新技术企业”资质
- 2010** Successively merged with Asiafuse (HK) Electronics Limited, Foshan Wholesome Electronics Co.,ltd., Tronic Electronics Limited., Wuxi Waltron Electronic Co.,ltd.,
先后并购艾弗电子(香港)公司，宏立信电子，创领电子，华创电子
- 2009** Accessed to the qualification of "Guangdong private science and technology enterprises"
获得“广东省民营科技企业”资质
- 2007** Accessed to "BSI ISO 9000" quality management system certification
获得“BSI ISO 9000”质量管理体系认证
- 2005** Comprehensively started using standard plants and office buildings
全面启用标准厂房和办公大楼
- 2003** August, Betterfuse came into being in the ruins of Wickman' s factory, which was took over by Littlefuse.
正式注册“东莞市贝特电子科技有限公司”

公司简介

OUR COMPANY

东莞市贝特电子科技股份有限公司于2003年系原德国WICKMANN(东莞)中国团队创办,公司定位全面电路保护元件制造商和方案供应商,目前已成为中国区行业领跑品牌。

我们的产品包含过流,过压,过温电路保护元件和复合产品以及相关配件,已经取得了TUV、VDE、UL、CSA、CCC、PSA、KC、ASTA等认证。公司前后取得了ISO14001、QC080000等体系认证;赢得了:三星、美的、LG、比亚迪等国内外知名企业的认可,并建立了长期、友好合作关系。

在电子、电力、新能源和工业电路保护市场上,为满足各种不同的安全技术要求和本土化服务,我们在亚洲、欧洲和美洲分别设立多个海外驻点办事处和代理机构。

多年来,我们历经了并购、重组、升级。从一个小车间开始,发展至今,以贝特卫士东莞松山湖总部为母体下辖4家分子公司的国家高新技术企业,通过优化人才、平台整合、扁平化管理、两化融合等方针和目标,不断提升企业核心竞争力。

在“品牌、活力、团队、效率、整合”企业五大核心理念的指引下,我们以雄厚的技术实力,导入了ERP等相关系统,并前瞻性地引入智能制造的先进设备和管理体系,与时俱进,为全球客户提供诚信、增值的服务。

Incorporated in 2003 on the foundations of the German WICKMANN' s factory in Dongguan, Better Group established and secured its the leader position on fuse industry as a manufacturer for total circuit protection components and brand operators in China.

Our product portfolio consists of fuses and components for over-current, over-voltage and over-temperature protection and related accessories, which are approved and certified through major international testing laboratories, such as TUV, VDE, UL, CSA, CCC, PSA, KC and ASTA. Has won the recognition from domestic and overseas famous enterprises, like Samsung, Midea, LG, BYD, and has established long-term and friendly cooperation relationship.

In the electronics, electricity, new power and industrial circuit protection market, in order to meet different safety requirements and localization service, We has respectively set up multiple overseas offices and agencies in Asia, Europe and America.

For many years, We experienced mergers and acquisitions, recombination and upgrade. It started from a small workshop and has developed till now. Taking the Dongguan Songshanhu Betel headquarter as the maternal and subordinating 4 branches, Betterfuse is a national high-tech enterprise. Through the targets and principles, like optimizing talents, platform integration, flat management, two-oriented integration, Betterfuse continuously improves core competitiveness of enterprises.

Under the guidance of the company's five core ideas-'Brand, Teamwork, Energy, Efficiency, Resources', with solid technical strength, We has implemented related systems, like ERP, and introduced advanced equipment of IM and management system prospectively. Keep pace with times so that to provide faithful and value-added services for the global clients.



松山湖总部



东莞一厂



佛山分公司



无锡分公司



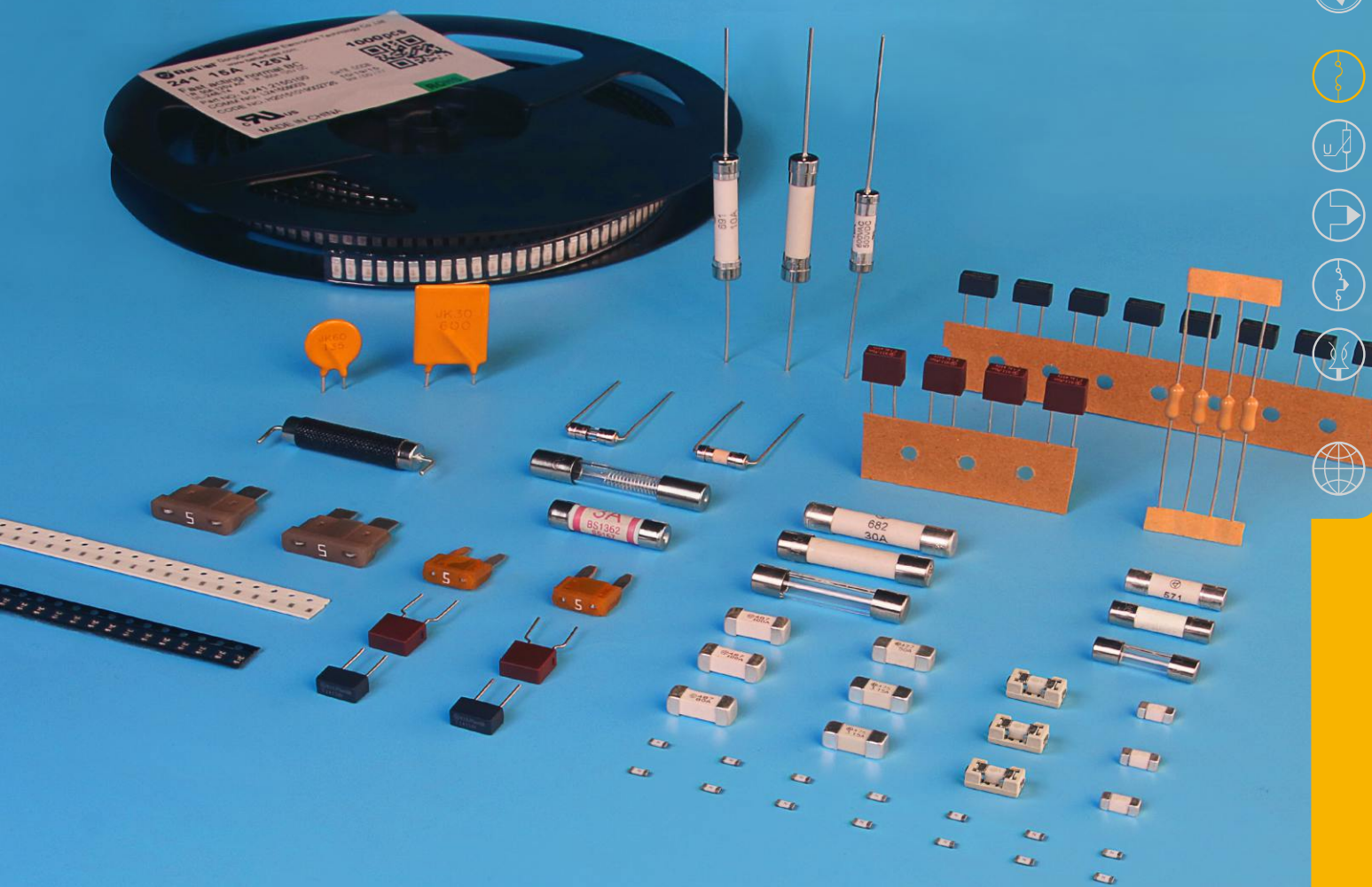

OC

Over Current Protection

Chip-Fuses, Brick-Fuses, Cylindrical Glass, Epoxy and Ceramic Fuses, PPTC, British Plug Top Fuses, Microwave Oven Fuses, Square/Box Fuses, Special Purpose Fuses, Automotive Fuses

SMD Fuses

ROHS HF

Voltage Range
Ampere Range
Breaking Capacity

SMD Fuse 0402 Size

Fast-Acting
041 Series



24/32VDC
200mA-4A
35A@32VDC[200mA-750mA]
35A@24VDC[1A-4A]

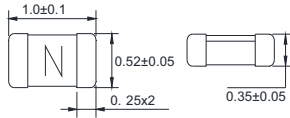

SMD Fuse 0603 Size

Time-Lag, high I²t
063 Series



32VDC
1A-5A
50A@32VDC[1A-5A]

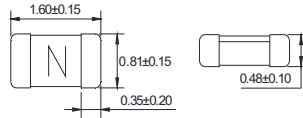

SMD Fuse 0603 Size

Fast-Acting
064 Series



63VDC
250mA-5A
50A@63VDC[250mA-1.5A]

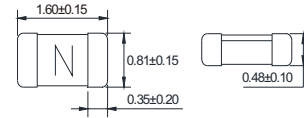
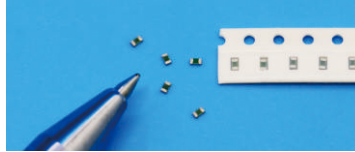

Voltage Range
Ampere Range
Breaking Capacity

SMD Fuse 0603 Size

Fast-Acting
065 Series



32VDC
250mA-8A
50A@32VDC[250mA-8A]

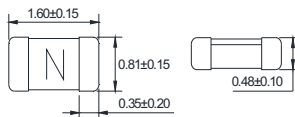

SMD Fuse 0603 Size

Time-Lag, high I²t
066 Series



32VDC
1A-8A
50A@32VDC[1A-8A]

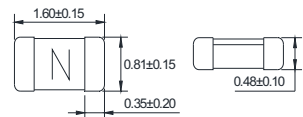

SMD Fuse 1206 Size

Time-lag
122 Series



36VDC/48VDC/63VDC/72VDC
100mA-30A
50A@72VDC/63VDC[4.5-7A]
150A@48VDC[8-20A]
150A@36VDC[25-30A]

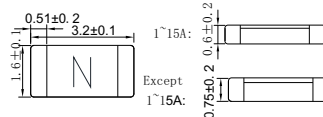

Voltage Range
Ampere Range
Breaking Capacity

SMD Fuse 1206 Size

Time-Lag, high I²t
123 Series



125VAC, 32/63VDC
1A-5A
50A@125VAC/63VDC[1-4A]
100A@125VAC/32VDC[4.5A-5A]

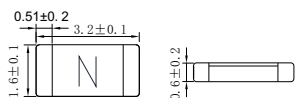

SMD Fuse 1206 Size

Fast-Acting, high voltage
124 Series



125VAC/DC
250mA-1.5A
50A@125VAC/DC[250mA-1.5A]

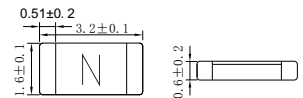

SMD Fuse 1206 Size

Fast-Acting
125 Series



72/63/32/24VDC
250mA-30A
50A@72/63/32VDC, 300A@24VDC[250mA-4A]
50A@32VDC, 300A@24VDC[4.5A-7A]
150A@32VDC, 300A@24VDC[8A-30A]

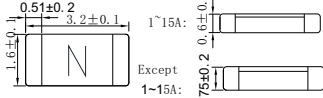

SMD Fuses

ROHS HF

	SMD Fuse 1206 Size Time-Lag, high I ² t 126 Series cULus	SMD Fuse 1206 Size Fast-Acting, high voltage 127 Series cULus	SMD Fuse 1206 Size Fast-Acting, high voltage 131 Series cULus
Voltage Range	72/63/45/32/24VDC	125VAC, 125/72VDC	125VAC, 72VDC
Ampere Range	750mA-30A	250mA-20A	1A-3A
Breaking Capacity	50A@72/63VDC[750mA-4A] 50A@32/45VDC[4.5A-7A] 50A@32VDC, 300A@24VDC[8A-30A]	250mA-20A/50A@125VAC/DC[250mA-3A] 50A@72VDC[3.5A-5A] 50A@72VDC/63VDC[6A-7A] 150A@48VDC/32VDC[8A-20A]	100A@125VAC/72VDC[1A-3A]

	SMD Fuse 2410 Size Fast-Acting 241 Series cULus	SMD Fuse 2410 Size Time-Lag 244 Series cULus, CCC, A, CCC, K	SMD Fuse 2410 Size Time-Lag, High I ² t 245 Series cULus
Voltage Range	125VAC/DC	250VAC, 125VDC	125VAC, 125VDC, 250VAC
Ampere Range	2A-15A	250mA-7A	250mA-7A
Breaking Capacity	50A or 10In@125VAC/DC[2A-10A] 50A@125VAC/DC[12A-15A]	100A@250VAC[250mA-7A] 50A@125VDC[250mA-7A]	100A@125VAC[250mA-7A] 50A@125VDC[250mA-7A]

	SMD Fuse 2410 Size Time-Lag, High Voltage 246 Series cULus	SMD Fuse 2410 Size Fast-Acting 247 Series cULus	SMD Fuse 2410 Size Fast-Acting, high current 249 Series cULus
Voltage Range	350VAC	125VAC, 125VDC	72VDC
Ampere Range	250mA-7A	375mA-1.6A	20A-30A
Breaking Capacity	50A@350VAC[250mA-7A]	100A@125VAC, 50A@125VDC[375mA-1.5A]	500A@72VDC[20A-30A]



SMD Fuse 1140 Size

Fast-Acting
475 Series



Voltage Range
Ampere Range
Breaking Capacity

250VAC/DC, 400VDC
400mA-10A
150A@250VAC/DC[400mA-5A]
150A@250VAC, 500A@72VDC, 1000A@32VDC[6.3A-10A]
50A@400VDC, 100A@350VDC(400mA-3.15A)

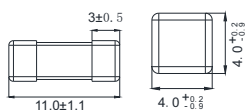
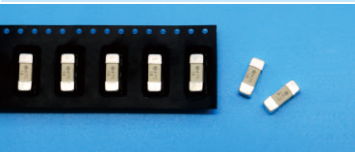

SMD Fuse 1140 Size

Time-Lag
476 Series



250VAC/DC, 400VDC
400mA-10A
150A@250VAC/DC[400mA-5A]
150A@250VAC, 500A@72VDC, 1000A@32VDC[6.3A-10A]
50A@400VDC, 100A@350VDC(400mA-3.15A)

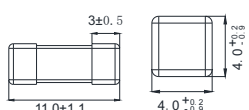

SMD Fuse 1140 Size

Time-Lag, high current
477 Series



125/250VAC, 72VDC
15A-60A
1KA@32VDC, 150A@250VAC, 500A@72VDC[15A-40A]
250A@125VAC, 500A@60VDC, 1000A@32VDC[15A-60A]

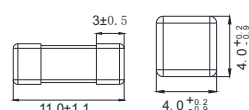

SMD Fuse 1245 Size

Time-Lag, high current
487 Series



Voltage Range
Ampere Range
Breaking Capacity

125/250VAC, 80/72/63/32VDC
20A-100A
800A@250/125VAC, [20-25A]
800A@80/72/63/32VDC
1kA@80/72/63/32VDC, 300A@250VAC, 500A@125VAC[40A]
500A@125VAC, 1kA@72/63/32VDC[50-100A]

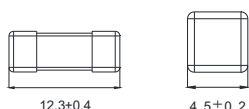

**Application
应用:**

Suitable for LED Light 适用于室内灯饰 : 2410 series
Electric Tools Power Battery Pack Protection 电动工具 动力电池包保护 : 477、249
Wireless Sweeper And Electric Cigarette Application Protection
无线吸尘器, 扫地机器人, 电子烟等家居型电池保护 : 066、126、249



Electric drill 电钻



Mower 割草机



Sweeper Machine 扫地机器



Wireless Vacuum Cleaner
无线吸尘器



Toy Car 电动玩具车



Balance Car 平衡车



BH240 Series



LED Light



Cartridge Fuses

ROHS HF

Voltage Range
Ampere Range
Breaking Capacity

Φ2*7mm Coated Tube Fuse

Fast-Acting
211 Series



250VAC
100mA-20A
50A@250/125VAC[100mA-2.5A]
35A@250/125VAC[3.15A-10A]
50A@32VAC, 100A@16VAC[12A-20A]

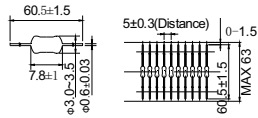
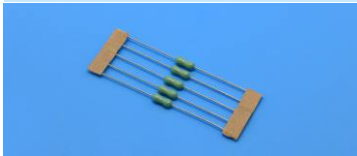

Φ2*7mm Coated Tube Fuse

Time-Lag
212 Series



250VAC
100mA-6.3A
50A@150/250VAC[100mA-2.5A]
35A@150/250VAC[3.15A-6.3A]

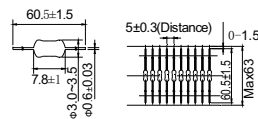

Φ4*13mm Coated Tube Fuse

Time-Lag
316 Series



350VAC
250mA-10A
150A@250VAC, 100A@350VAC[250mA-10A]

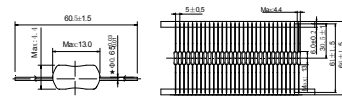

Voltage Range
Ampere Range
Breaking Capacity

Φ3.6*10mm Glass Tube Fuse

Fast-Acting
311 Series



250VAC
250mA-12A
50A@250VAC[250mA-12A]

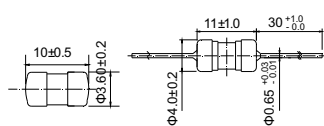
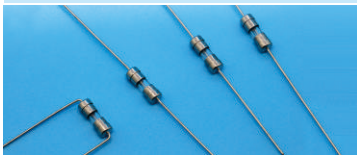

Φ3.6*10mm Glass Tube Fuse

Time-Lag
312 Series



250VAC
250mA-10A
50A@125/250VAC[250mA-10A]

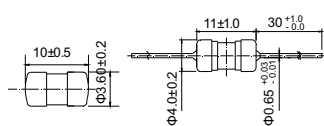
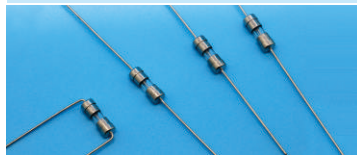

Φ3.6*10mm Glass Tube Fuse

Fast-Acting
331 Series



250VAC/125VAC
250mA-10A
50A@125VAC
35A or 10In@250VAC[250mA-6.3A]
50A@250VAC[7A-10A]

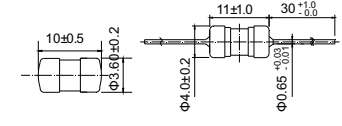

Voltage Range
Ampere Range
Breaking Capacity

Φ3.6*10mm Glass Tube Fuse

Time-Lag
332 Series



250VAC/125VAC
250mA-10A
50A@125VAC
35A or 10In@125/250VAC[250mA-8A]
50A@250VAC[10A]

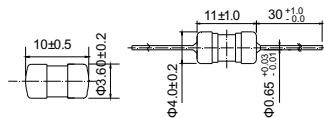

Φ3.6*10mm Ceramic Tube Fuse

Fast-Acting
333 Series



250VAC/125VAC
250mA-10A
50A@125VAC[200mA-10A]
35A or 10In@250VAC[200mA-6.3A]
50A@250VAC[7A-10A]

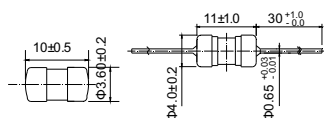
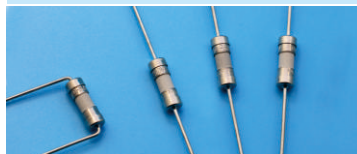

Φ3.6*10mm Ceramic Tube Fuse

Time-Lag
334 Series



250VAC/125VAC
200mA-10A
50A@125VAC[200mA-10A]
35A or 10In@250VAC[200mA-6.3A]
50A@250VAC[7A-10A]

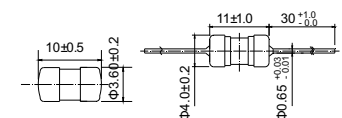
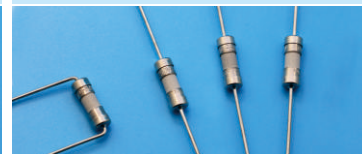

Cartridge Fuses

ROHS HF

	Φ5*20mm Glass Tube Fuse Time-Lag 511 Series	Φ5*20mm Glass Tube Fuse Time-Lag 512 Series	Φ5*20mm Glass Tube Fuse Fast-Acting 521 Series
Voltage Range	250VAC/125VAC	250VAC/125VAC	250/125VAC
Ampere Range	250mA-15A	250mA-15A	250mA-16A
Breaking Capacity	10KA@125VAC, 35A@250VAC[250mA-800mA] 10KA@125VAC, 100A@250VAC[1A-3.5A] 10KA@125VAC, 200A@250VAC[4A-6.3A] 100A@125V/250VAC[7A-15A]	10KA@125VAC, 35A@250VAC[250mA-800mA] 10KA@125VAC, 100A@250VAC[1A-6.3A] 400A@125VAC, 100A@250VAC[7A-15A]	10KA@250VAC[250mA-16A] 100A@250VAC[250mA-16A]

	Φ5*20mm Glass Tube Fuse Time-Lag 522 Series	Φ5*20mm Ceramic Tube Fuse Fast-Acting, high breaking capacity 523 Series	Φ5*20mm Ceramic Tube Fuse Time-Lag, high breaking capacity 524 Series
Voltage Range	250VAC	250VAC/125VAC	250VAC/125VAC
Ampere Range	100mA-16A	500mA-10A	500mA-25A
Breaking Capacity	35A or 10In@250VAC[100mA-16A]	1500A@250VAC[500mA-10A] 10KA@125VAC[500mA-10A]	1500A@250VAC[500mA-16A] 200A@250VAC, 400A@125VAC[20A-25A] 10KA@125VAC[500mA-16A]

	Φ5*20mm Ceramic Tube Fuse Fast-Acting 525 Series	Φ5*20mm Glass Tube Fuse Fast-Acting, single cap 527 Series	Φ5*20mm Ceramic Tube Fuse Fast-Acting 531 Series
Voltage Range	125VAC/250VAC, 300VDC/420VDC	250VAC	300VAC/DC
Ampere Range	250mA-25A	12.5A, 16A	200mA-30A
Breaking Capacity	1500A@250VAC, 500A@420VAC[500mA-25A] 1000A@300VDC, 300A@420VDC[500mA-25A]	125A@250VAC[12.5A, 16A]	3KA@300VAC/DC[200mA-10A] 300A@300VAC/DC[12A-30A]



Cartridge Fuses

ROHS HF

Voltage Range
Ampere Range
Breaking Capacity

Φ5*20mm Ceramic Tube Fuse Fast-Acting 571 Series

600VAC, 420VACDC
200mA-20A
300A@420VDC [200mA-20A] 200A@600VAC [1.25A-20A]

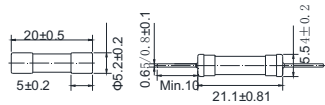

Φ5*20mm Ceramic Tube Fuse Fast-Acting 573 Series

500VDC
200mA-20A
300A@500VDC, 2KA@400VDC [200mA-10A] 300A@500VDC [12A-20A]

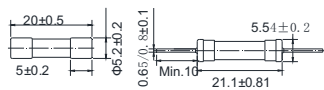

Φ5*20mm Ceramic Tube Fuse Time-Lag 582 Series

600VAC, 500VDC
500mA-20A
200A@600VAC, 300A@500VDC, 2KA@400VDC [500mA-10A] 200A@600VAC, 300A@500VDC [12A-20A]

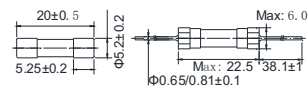

Voltage Range
Ampere Range
Breaking Capacity

Φ6*30mm Glass Tube Fuse Fast-Acting 611 Series

250VAC/125VAC
500mA-25A
10KA@125VAC, 35A@250VAC [500mA-800mA] 10KA@125VAC, 100A@250VAC [1A-3A] 10KA@125VAC, 200A@250VAC [3.15A-20A] 300A@125VAC [25A]

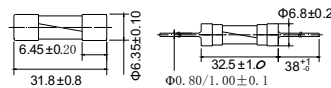

Φ6*30mm Glass Tube Fuse Time-Lag 612 Series

250VAC/125VAC
500mA-30A
10KA@125VAC, 35A@250VAC [500mA-1A] 10KA@125VAC, 100A@250VAC [1.25A-3.5A] 10KA@125VAC, 200A@250VAC [4A-8A] 400A@125VAC, 200A@250VAC [10A-20A] 400A@125VAC, 100A@250VAC [25A-30A]

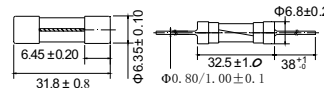

Φ6*30mm Ceramic Tube Fuse High I²T and Surge withstand to 20 cycles of 20kV 610 Series

600VAC/150VDC
21A
200A@600V AC 200A@150V DC

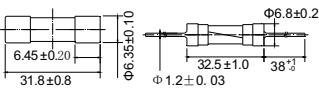

Voltage Range
Ampere Range
Breaking Capacity

Φ6*30mm Ceramic Tube Fuse Fast-Acting 613 Series

250VAC
500mA-25A
10kA@125VAC, 35A@250VAC [500mA-1A] 10kA@125VAC, 100A@250VAC [1.25A-3.5A] 10kA@125VAC, 200A@250VAC [4A-10A] 400A@125VAC, 200A@250VAC [12A-20A] 400A@125VAC, 200A@250VAC [25A]

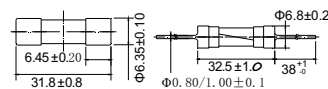

Φ6*30mm Ceramic Tube Fuse Time-Lag 614 Series

250VAC/125VAC
500mA-30A
10kA@125VAC, 35A@250VAC [500mA-800mA] 10kA@125VAC, 100A@250VAC [1A-3.5A] 10kA@125VAC, 200A@250VAC [4A-20A] 400A@125VAC, 100A@250VAC [500mA-30A]

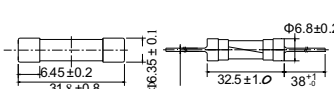

Φ6*30mm Ceramic Tube Fuse Fast-Acting 615 Series

1000VAC/660VAC
500mA-10A
100A@1000VAC [500mA-10A] 300A@660VAC [500mA-10A]

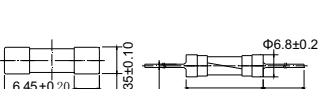

Cartridge Fuses / 500VDC-1000VDC

ROHS HF

Voltage Range
Ampere Range
Breaking Capacity

Φ6*30mm Ceramic Tube Fuse

Time-lag
616 Series
cRU_{us} 

250VAC
15A-50A
1500A@250VAC[15A-50A]

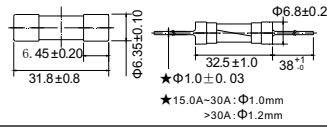
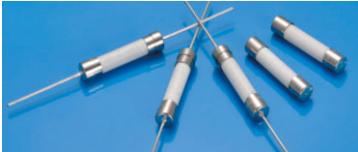

Φ6*30mm Ceramic Tube Fuse

Fast-Acting
617 Series
cRU_{us}

250VAC/150VDC
30A-50A
*40A High 1500A@250VAC, 200A@150VDC

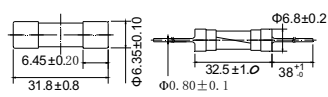
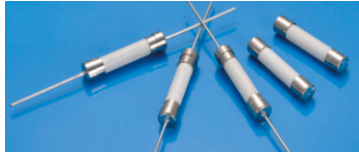

Φ6*30mm Ceramic Tube Fuse

Fast-Acting
619 Series
cRU_{us}

660VAC/500VAC
15A-40A
400A@660VAC, 800A@500VAC

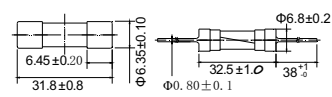
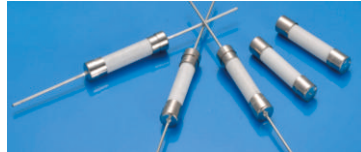

Voltage Range
Ampere Range
Breaking Capacity

Φ6*30mm Ceramic Tube Fuse

Fast-Acting
682 Series
cRU_{us}

500VAC, 500VDC
10A-30A
30KA@500VAC[10A-30A] 20KA@500VDC[10A-30A]

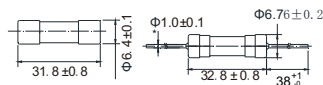

Φ6*30mm Ceramic Tube Fuse

Fast-Acting
683 Series
cRU_{us}

500VAC, 500VDC
20A-30A
1KA@500VAC/DC[20A-30A]

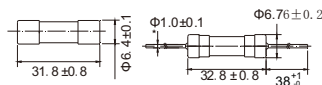

Φ6*30mm Ceramic Tube Fuse

Fast-Acting
691 Series
cRU_{us}

600VAC, 600VDC
200mA-12A
10KA@600VAC/DC[200mA-12A]

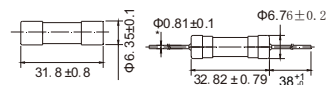

Voltage Range
Ampere Range
Breaking Capacity

Φ6*30mm Ceramic Tube Fuse

Fast-Acting
692 Series
cRU_{us}

660VAC, 660VDC
200mA-30A
1KA@660VAC/DC[200mA-30A]

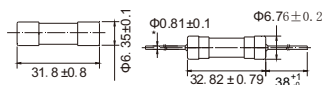

Φ6*30mm Ceramic Tube Fuse

Fast-Acting
693 Series
cRU_{us}

1000VAC, 1000VDC
200mA-3A
10KA@1000VAC/DC[200mA-3A]

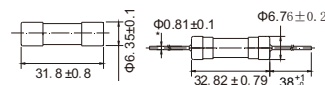

Φ6*30mm Ceramic Tube Fuse



Fast-Acting
697 Series
cRU_{us}

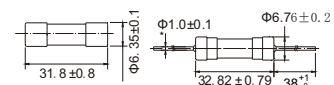

400VAC
30A
1KA@400VAC[30A]

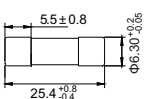
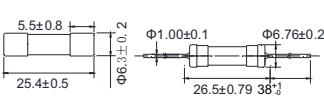
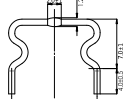

Cartridge Fuses / Car Fuses / Through Hole Fuses

ROHS HF

	British Plug Top Fuse Fast / Medium AF63 Series, BS1362-1973	Φ6*25mm Ceramic Tube Fuse Time-Lag 671 Series	Φ12.5*11mm melting wire Fuse 253 Series
Voltage Range	264VAC	75VDC	80VDC
Ampere Range	1A, 2A, 3A, 5A, 7A, 10A, 13A	5A-50A	30A~100A
Breaking Capacity	6KA@264VAC[1A~13A]	2.5kA@75VDC[5A-50A]	
			
			

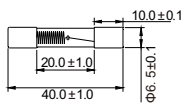
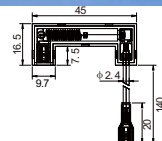
	Φ6*40mm Glass Tube Fuse Fast-Acting, Microwave Dedicated 720 Series	Φ6*40mm Glass Tube Fuse Fast-Acting, Microwave Dedicated 721 Series	Small Car Fuse Mini BF2 Series
Voltage Range	5KVAC	5KVAC	32VDC
Ampere Range	400mA~1A	400mA~1A	3~30A
Breaking Capacity	5KVAC[400mA~1A]	5KVAC[400mA~1A]	1000A@32VDC[3~30A]
			
			

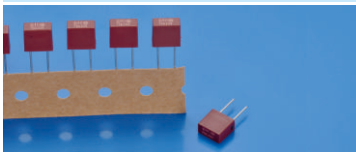
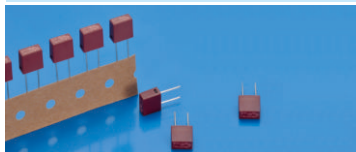
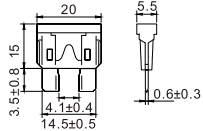
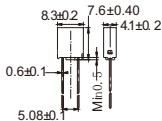
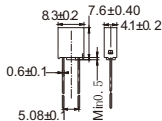
	Middle Car Fuse Max 718&BF4 Series	TE5 Fuse Fast-Acting 931 Series	TE5 Fuse Time-Lag 932 Series
Voltage Range	32VDC	250VAC	300VAC/250VAC
Ampere Range	2~40A	100mA~10A	100mA~10A
Breaking Capacity	1000A@32VDC[2~40A]	130A@125/250VAC[100mA~10A]	100A@250VAC[100mA~10A], 50A or 10In@300VAC[100mA~10A]
			
			



Cartridge Fuses / Car Fuses / Through Hole Fuses

ROHS HF

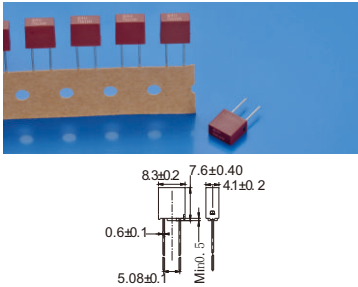
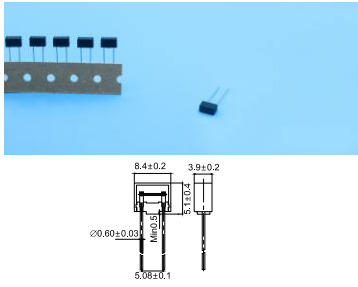
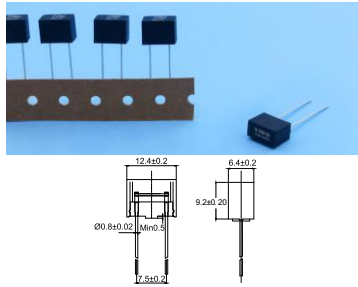
	TE5 Fuse Fast-Acting, high voltage 933 Series	TK5 Fuse Time-Lag, high voltage 936 Series	NEW TK5 Fuse High I ² t 938 Series
Voltage Range	400VAC, 250VDC	400VAC/250VAC, 250VDC	250VAC/350VAC
Ampere Range	100mA~10A	100mA~10A	100mA~16A
Breaking Capacity	100A@400VAC, 100A@250VDC[100mA~10A]	100A@400VAC[100mA~10A] 130A@250VAC[100mA~10A] 60A@250VDC[100mA~10A]	200A@250VAC
			

Application 应用:

British Plug 英规插头 : AF63

AC Charge Spots 交流充电桩 : 616 617

Multimeter High Voltage Low Current 万用表高压小电流 : 691 693



High Voltage Variable Frequency
Converter Control Board
高压变频控制板



UPS Uninterrupt Power Supply
UPS 电源



Multimeter
万用表



British Plug
英规插头







Charging Pile
充电桩



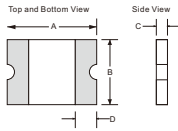
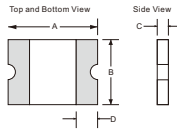
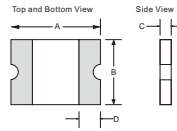

SMD PPTC Fuses

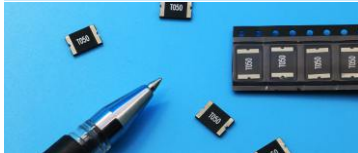
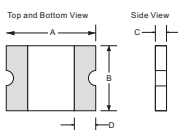
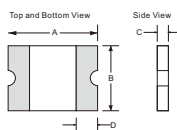
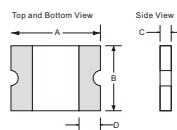
ROHS HF

	TLC-FSMD 0603 Size SMD PPTC	TLC-PSMD 0805 Size SMD PPTC	TLC-NSMD 1206 Size SMD PPTC
Voltage Range	6~15V DC	6~24V DC	6~30V DC
Current Range	0.10A~0.50A	0.10A-1.10A	0.05A-2.00A
			
			
	TLC-USMD 1210 Size SMD PPTC	TLC-MSMD 1812 Size SMD PPTC	TLC-LSMD 2920 Size SMD PPTC
Voltage Range	6~30V DC	6~60V DC	6~60V DC
Current Range	0.05A-2.00A	0.10A-3.00A	0.10A-3.00A
			
			



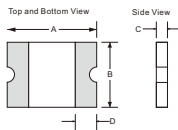
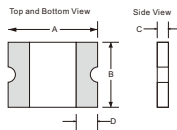
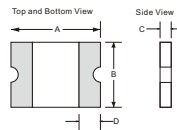

SMD Low Resistance PPTC

	TLC-PSML 0805 Size SMD PPTC	TLC-NSML 1206 Size SMD PPTC	TLC-USML 1210 Size SMD PPTC
Voltage Range	6V DC	6V DC	6V DC
Current Range	0.75A~3.00A	1.10A-7.50A	1.10A-7.50A
			
			

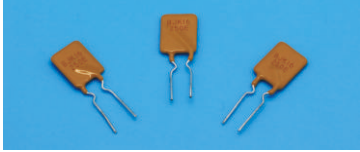
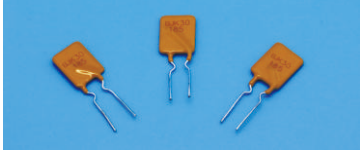
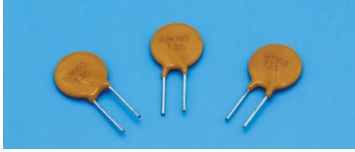
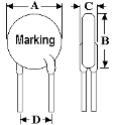
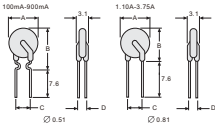
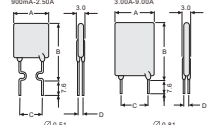

Through Hole PPTC Fuses/ESD Suppressor

ROHS HF

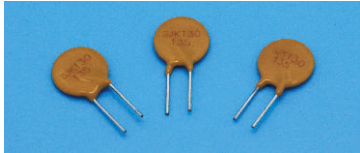
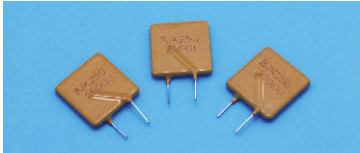
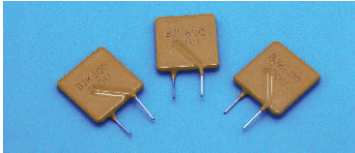
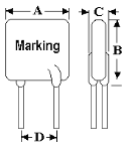
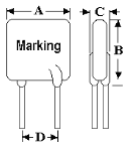
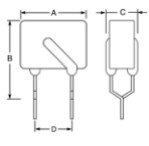
	BJK16	BJK30	BJK60
Voltage Range Current Range	16V DC 0.10A-14.00A	 30V DC 0.75A-9.00A	 60V DC 0.05A-5.00A
			
			
	BJK130	BJK250	BJK600
Voltage Range Current Range	130V DC 0.06A-3.75A	 60V DC, interrupt voltage 250V DC 0.02A-2.00A	60V DC, interrupt voltage 400V DC 0.05A-4.00A
			
			

Application 应用:

Suitable for USB, HMDI and other mainboard interface protections 适用于主板的USB, HMDI等接口保护
 Door lock motor, power windows motor, vehicle navigation and other automotive electronic protections
 门锁电机, 电动车窗, 车载导航等汽车电子保护
 Switches, code scanning device and other communication equipment protections
 交换机, 扫码枪等通讯设备保护



Computer equipment
电脑设备



Automotive electronics
汽车电子



Telecommunications equipment
电信设备



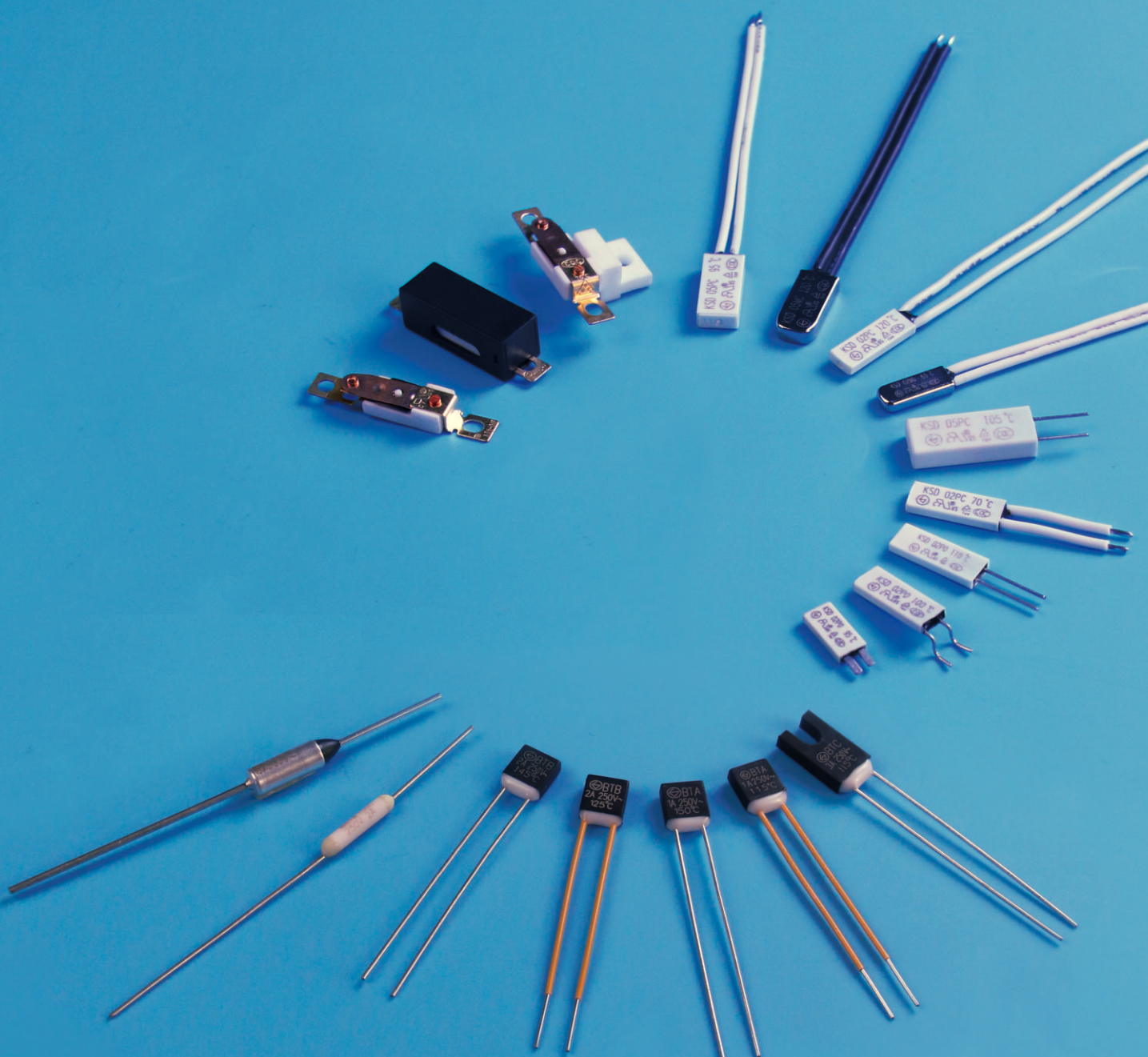

OT-F / OT-S

Over Temperature Protection

Thermal Cut-Off Fuses, High Precision Thermostats
And Switches

Thermal Protection

Current / Voltage Range
Operation Temperature Range

Thermal Fuse BTT-10A Series



10A/250VAC
73°C~240°C

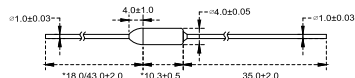

Thermal Fuse BTT-15A Series



15A/250VAC
73°C~240°C

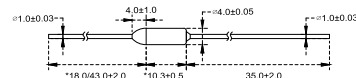

Thermal Fuse BTW Series



1A/2A@250VAC
115°C-150°C

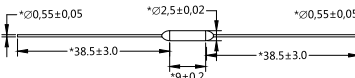

Current / Voltage Range
Operation Temperature Range

Thermal Fuse BTA Series



1A/250VAC
115°C~150°C

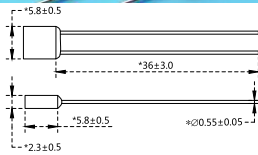

Thermal Fuse BTB Series



2A/250VAC
115°C~150°C

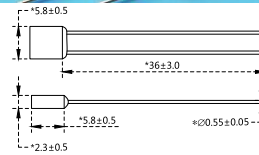
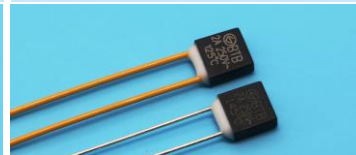

Thermal Fuse BTC Series



3A/250VAC
115°C-150°C

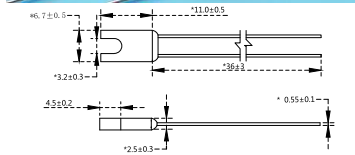

Current / Voltage Range
Operation Temperature Range

Thermal Switch KSD02(mini) Series



2A/250VAC, 3A/125VAC
50°C~150°C

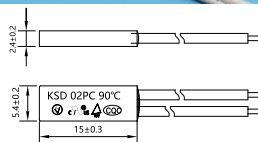

Thermal Switch KSD05 Series



5A/250VAC, 8A/115VAC, 10A/24VDC
60°C~150°C

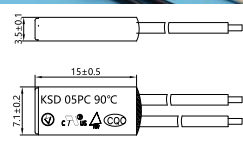

Thermal Switch ATM Series



10A/250VAC, 16A/125VAC
60°C-150°C

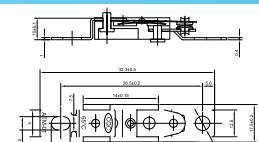



OV Over Voltage Protection

ESD Suppressors

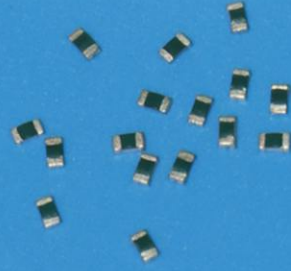
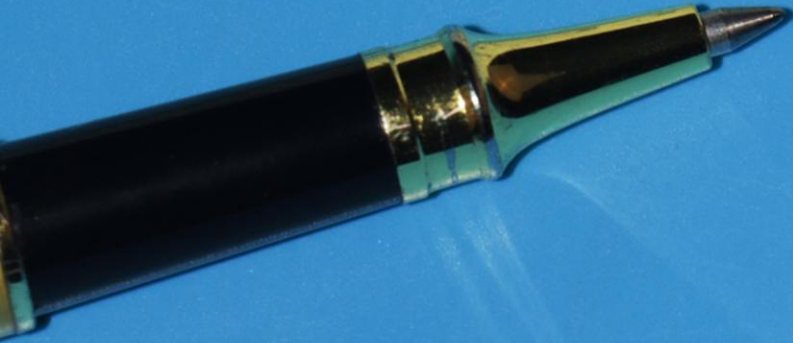

ESD Suppressor

0402 Size ESD Suppressor 0402ESD-P

24VDC
0.05pF
15KV air
8KV contact



0402 Size ESD Suppressor-4P 0402ESD-4P

35VDC
0.10pF
15KV air
8KV contact

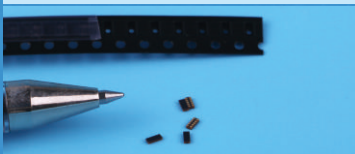

0603 Size ESD Suppressor 0603ESD-P

24VDC
0.05pF
15KV air
8KV contact



Voltage Range
Capacitance Range
ESD

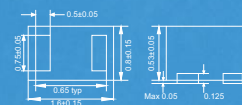
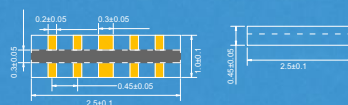
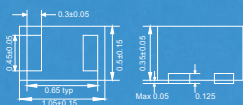

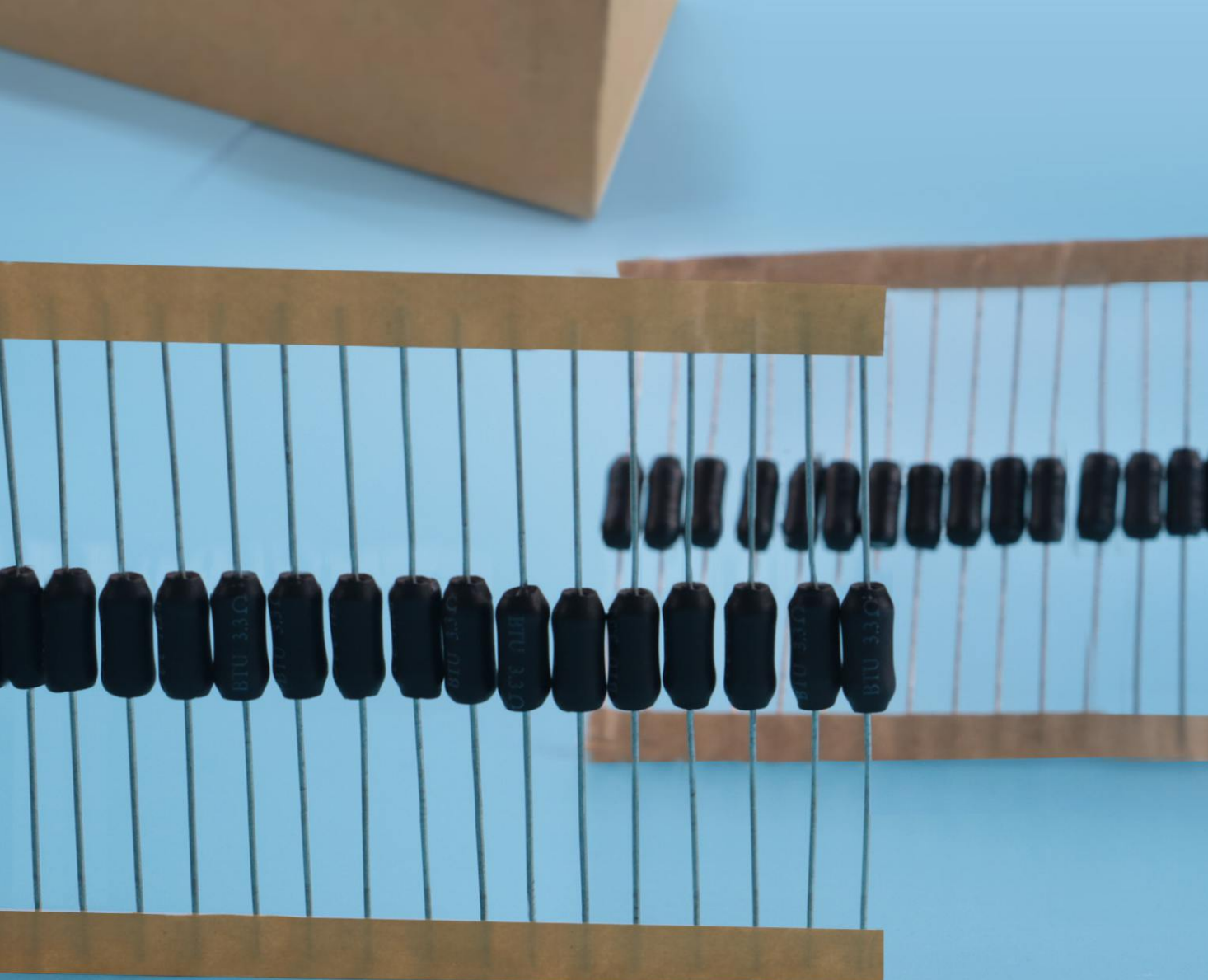

Multiple Protection



BTU Series

Resistance: 0.1Ω~300.0Ω
Rated Power: 0.5W, 1W, 2W
Tf:222°C





Accessories

Fuse Terminals, Clips, Holders, USB-C, Assembly

Fuse Holders

ROHS HF

	Fuse Holder FH1-12-P, FH1-12-M	Fuse Holder FH1-520-P	Fuse Holder FH1-S-MZ, FH1-S-PZ
Voltage/Current	250VAC/10A	250VAC/10A	250VAC/10A
UL Rating	UL 94V0	UL 94V0	UL 94V0
Mounting	Φ5*20mm	Φ5*20mm	Φ5*20mm

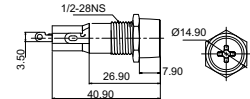
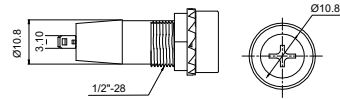
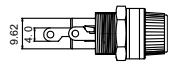

	Fuse Holder FH1-B-PZ, FH1-B-MW, FH1-B-MZ, FH1-B-PW	Fuse Holder FH1-2	Fuse Holder FH1-13
Voltage/Current	250VAC/10A	250VAC/10A	250VAC/10A
UL Rating	UL 94V2	UL 94V2	UL 94V0
Mounting	Φ5*20mm	Φ6*30mm	Φ6*30mm

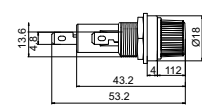
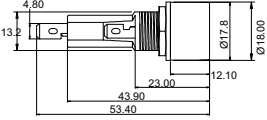
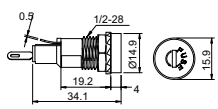

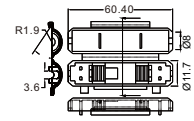
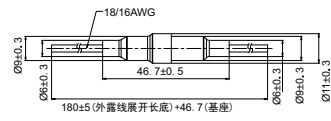
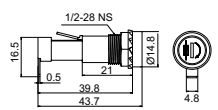

	Fuse Holder FH201-9-PW, FH201-9-PZ, FH201-9-MW, FH201-9-MZ	Fuse Holder FH-208	Fuse Holder for Φ6 *30mm Fuse BE 602
Voltage/Current	250VAC/15A	250VAC/6.3A	250VAC/15A
UL Rating	UL 94V2	UL 94V0	UL 94V0
Mounting	Φ6*30mm	Φ5*20mm	Φ6*30mm







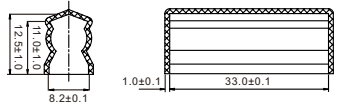
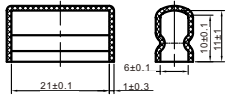
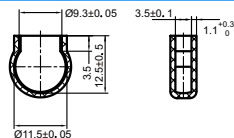

ACCESSORIES TERMINAL

Fuse Holders

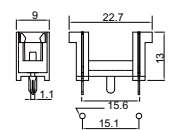
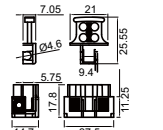
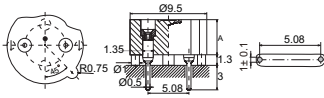
ROHS HF

	Fuse Cover PVC ROHS (FPFC21-6-11B) BH 503	Fuse Cover PVC ROHS (FPFC33-11 630) BH 603	Varistor sheathed BH 701, BH 702
Voltage/Current UL Rating Mounting	250VAC/10A UL94V0 Φ5*20mm	250VAC/30A UL94V0 Φ6*30mm	- UL94V0 7D, 14D Varistor
			
			

	Fuse Holder BH 501	Fuse Holder BE 502	Fuse Holder BH 800
Voltage/Current UL Rating Mounting	250VAC/10A UL 94V0 Φ5*20mm	250VAC/10A UL94V0 Φ5*20mm	250VAC/10A UL 94V0 TE5 Fuse(H=3.0mm, H=4.3mm)
			
			

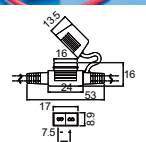
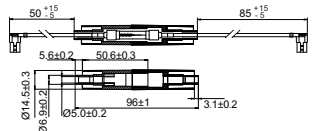
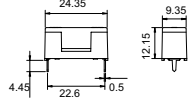
	Fuse Holder BE 701, BE 702	Fuse Holder 720xxxx504	Fuse Holder FH1-200CK-B, FH1-200CK-G
Voltage/Current UL Rating Mounting	32VDC/40A UL94V0 Car Fuse	5KV 1A PP F600 UL 94V0 Φ40*6.5mm	 250VAC/10A UL 94V2 Φ5*20mm
			
			



Fuse Clips/Terminals

ROHS HF

Material
Plating
Thickness
Mounting

Fuse Clips BC501-035, BC501-040

Copper H62
Nickel
0.35mm, 0.4mm
Φ5*20mm

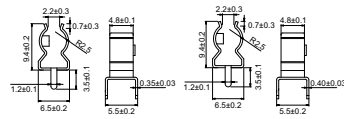

Fuse Clips BC502-040

High purity phosphor copper
Nickel
0.4mm
Φ5*20mm

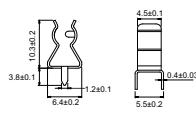

Fuse Clips BC507-040

Copper H62
Nickel
0.4mm
Φ5*20mm

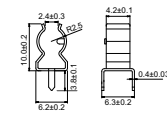

Fuse Clips BC511-240-A

Material
Plating
Thickness
Mounting

High precision phosphor copper bright
Bright Sn
0.4mm
Φ5*20mm

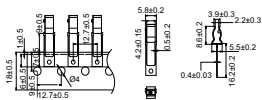
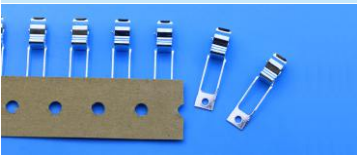

Fuse Clips BC522-040

Copper H62
Nickel
0.4mm
Φ5*20mm

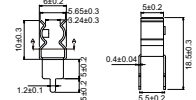

Fuse Clips BC600-040

Copper H62
Nickel
0.4mm
Φ6*30mm

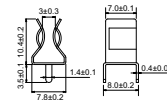

Fuse Clips BC603-050

Material
Plating
Thickness
Mounting

Copper H62
Nickel
0.5mm
Φ6*30mm

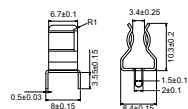

Fuse Clips BC603-250

Copper H62
Nickel Bright Sn
0.5mm
Φ6*30mm

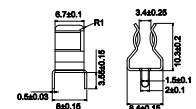

Insert Terminal BT001-050-A

Copper H62, semi-hard
Nickel
4.7mm

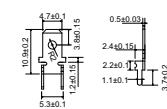
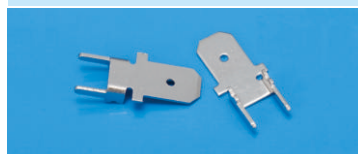

Material
Plating
Thickness

Insert Terminal
BT002-075-A, BT002-080

Copper H62, sermi-hard
Nickel
0.75mm, 0.8mm

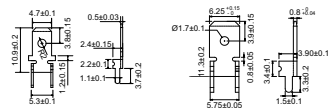

Insert Terminal
BT004-080

Copper H62, sermi-hard
Nickel
0.8mm, 4Pins

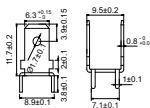

Insert Terminal
BT020-230

Iron
Bright Sn
0.3mm

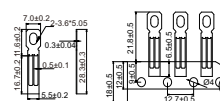
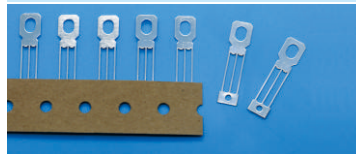

Material
Plating
Thickness

Insert Terminal
BT025-040

Copper H62, sermi-hard
Nickel
0.8mm

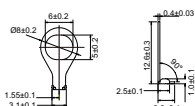

Insert Terminal
BT027-180A

Copper H65, Semi-hard, tapping
Matte Sn
Coating thickness $\geq 3\mu\text{m}$, 6Pins

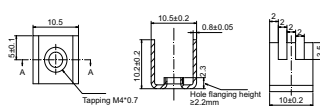

Insert Terminal
BT029-150

Copper H62, sermi-hard
Matte Sn
3~6 μm

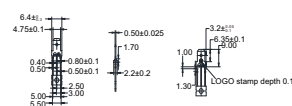
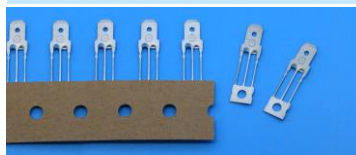

Material
Plating
Thickness

Insert Terminal
BT030-240

Copper H65, Semi-hard
Bright Sn
1~3 μm

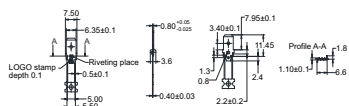
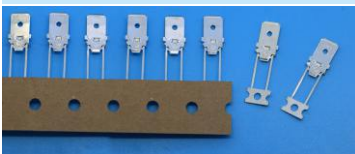

Car Fuse Insert Terminals
For BF2
BC 701

Phosphor Bronze
Ni Plated, Bright Sn Plated
0.8mm

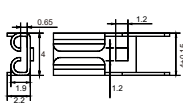

Car Fuse Insert Terminals
For BF4/718
BC 702

Phosphor Bronze
Ni Plated, Bright Sn Plated
0.8mm

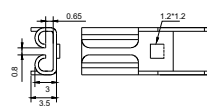



National High-tech Enterprise
 SC 32C National Technical
 Committee Member of China
 Intertek ISO 9001 Certificated Company
 Intertek ISO 14001 Certificated Company
 Intertek QC 080000 Certificated Company
 NQA IATF 16949 Certificated Company

国家高新技术企业
 SC 32C 国内专家组成员单位
 ISO 9001 认证企业
 ISO 14001 认证企业
 QC 080000 认证企业
 IATF 16949 认证体系

■ Headquarters 总部

东莞市贝特电子科技股份有限公司
 Add.: Room 601 of 16Block, No.1 Headquarters Valley, Hsinchu Road, Songshan Lake
 High-tech Industrial Development Zone, Dongguan city Guangdong Province P.R.C.
 Tel: +86-769-2307 8202 / 2307 8212
 Fax: +86-769-8352 1857
 Website: www.betterfuse.com
 地址: 广东省东莞市松山湖高新技术产业开发区新竹路总部一号, 16栋六楼



Website



Wechat public account

Subsidiaries 集团成员

■ 贝特卫士 (香港)

Asiafuse (HK) Electronics Limited
 E-mail: davidhan@betterfuse.com

■ 贝特卫士 (寮步)

Tel: 86+769-8323 8731 / 8323 8732 E-mail: sls01@betterfuse.com

■ 贝特卫士 (佛山)

Tel : +86-757-82511089 / 82216739 E-mail: sls18@betterfuse.com

■ 贝特卫士 (无锡)

Tel: +86-510-85296619 / 85228806 E-mail: jameszhou@betterfuse.com

■ 贝特卫士 (台湾)

Tel: +886-921-617539 E-mail: sls29@betterfuse.com

■ 贝特卫士 (日本)

Tel: +81-80-54955070 E-mail: tamotsu.matsunaga@betterfuse.com

Authorized Agent 特约经销商

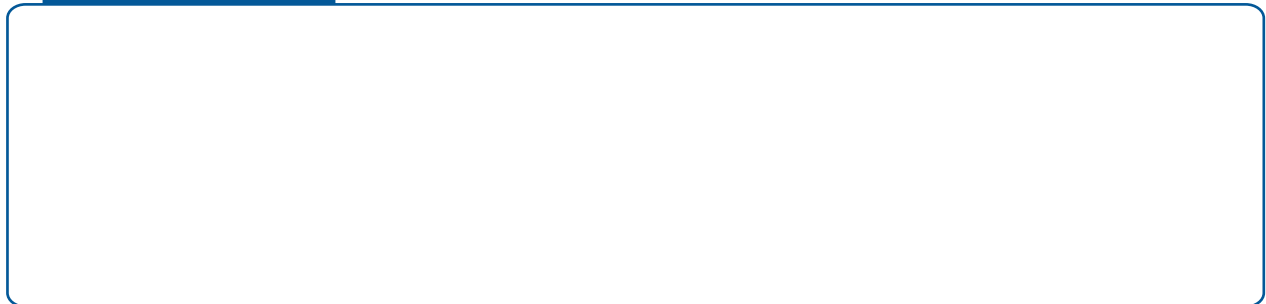

► Ask for copies of our detailed product catalogs or visit our website at: www.betterfuse.com